

Status of FFAGs at KURRI

FFAG12, Osaka
Nov. 15 2012

Y.Ishi, Y.Kuriyama, J-B. Lagrangian, Y.Mori, Tom Uesugi,
Kyoto University Research Reactor Institute, Osaka, Japan

Amy Yamakawa, Graduate School of Engineering, Kyoto
University, Kyoto, Japan

Y. Itoh, T. Minamikawa, I.Sakai, M. Takabatake
Fukui University, Fukui, Japan

K.Okabe, JAEA, Ibaraki, Japan

Outline

1. Brief summary of the original design and the H- injection
2. What we did since the last workshop FFAG I I
3. History of beam intensity and energy upgrade in recent 4 years
4. Road map of beam intensity upgrade
5. Future of FFAGs at KURRI
6. Simulation studies of beam stacking
7. Summary

Summary of the original FFAG complex in KURRI

A five-year program "Research and Development for an Accelerator-Driven Sub-critical System Using an FFAG Accelerator" was approved by MEXT in FY2002.

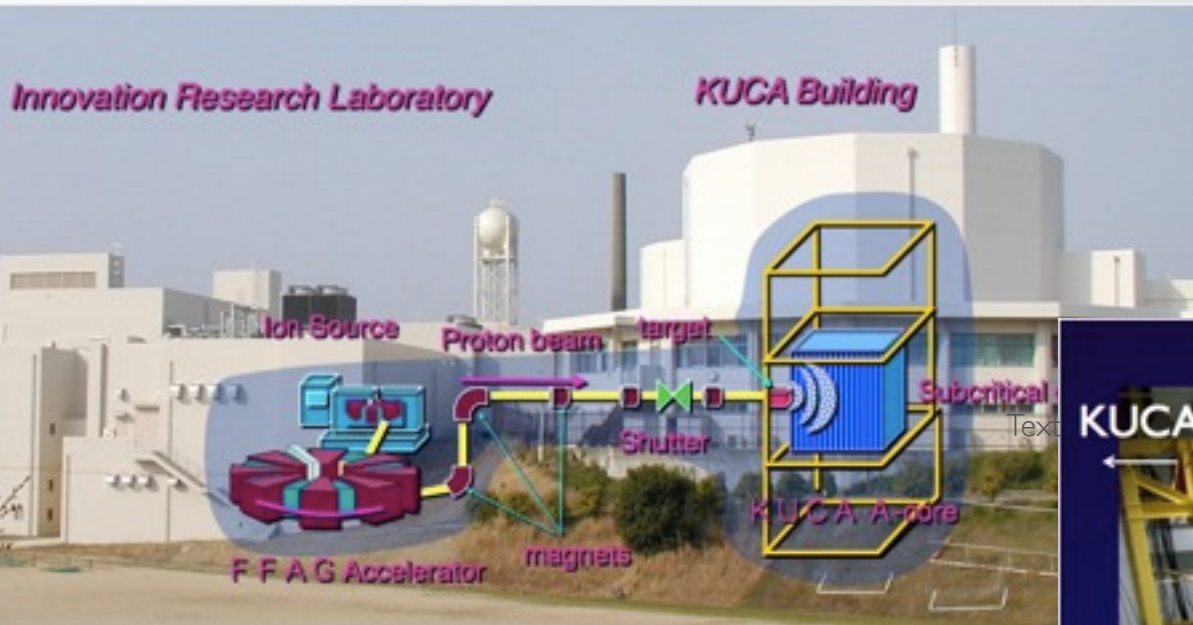

World first experiments of ADSR
 FY2008 : Uranium core
 FY2009 : Thorium core

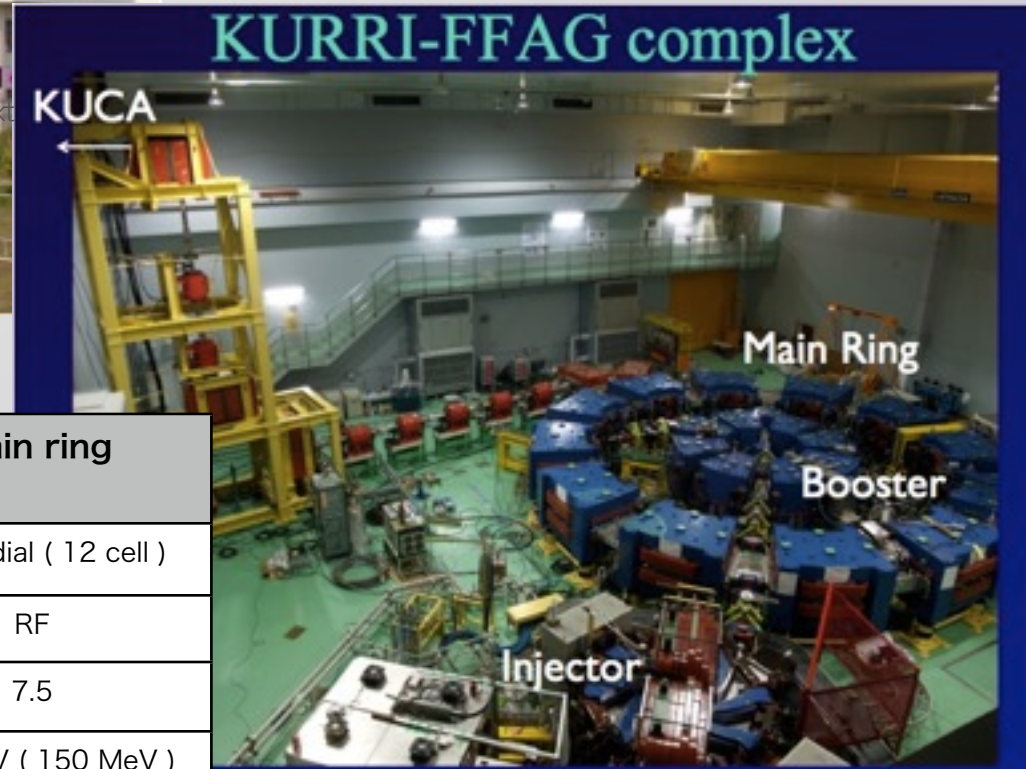

	Injector (Ion-beta)	Booster	Main ring
Lattice	spiral (8 cell)	DFD radial (8 cell)	DFD radial (12 cell)
Acceleration	Induction	RF	RF
k-value	2.5 (variable)	2.5	7.5
Energy	1.5 MeV (2.5 MeV)	11 MeV (20 MeV)	100 MeV (150 MeV)
average radius	0.60 - 0.99 m	1.42 - 1.71 m	4.54 - 5.12 m

Beam characteristics of FFAGs at the end of FY2009

Ion beta peak current $25\mu\text{A}$

spiral sector, induction acceleration, variable energy by using multi coil : first trial for the proton FFAG

induction scheme : energy fluctuation is large \rightarrow poor stability of the injection to the booster

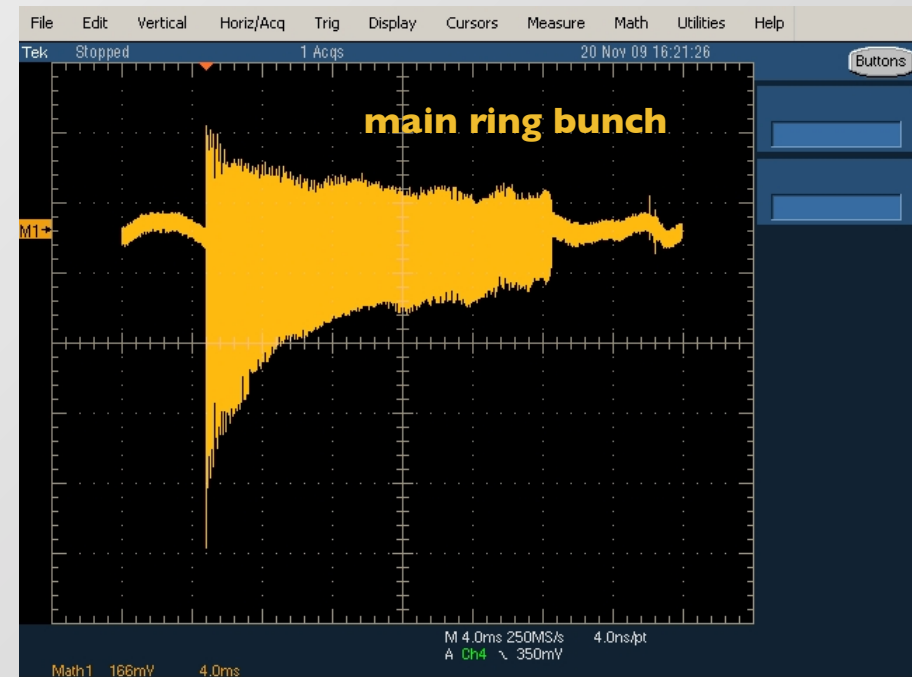
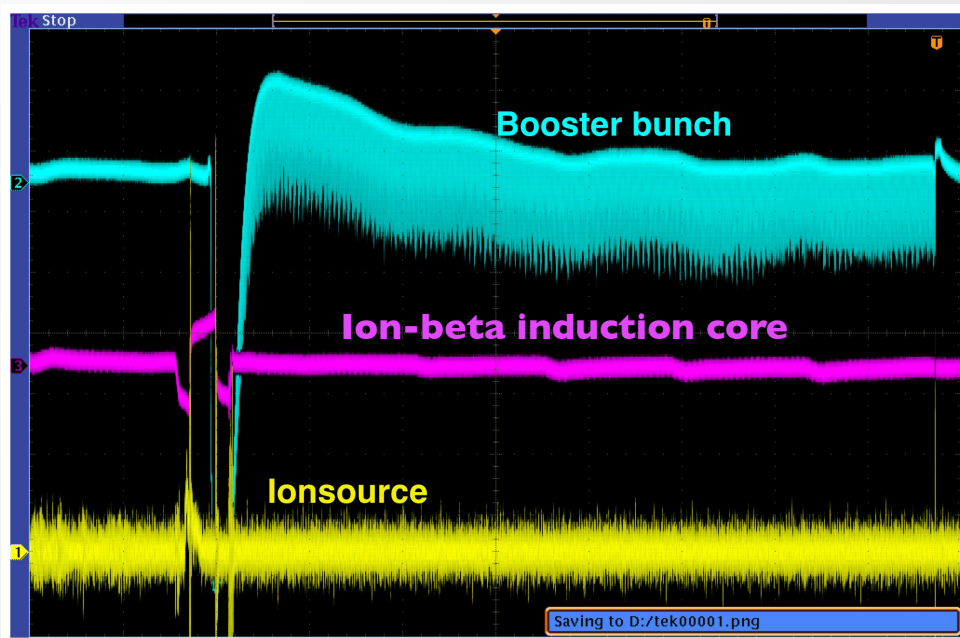

Booster average current 1.5nA (duration $7\mu\text{s}$ i.e. 14-turn injection)

Highly completed machine : It took only a few hours to reach final energy once we got rf capture.

It realized designed characteristics \rightarrow no beam loss

needs optimization of injection angle by adjusting the injection septum magnet

Main ring average current 0.1nA

Return-yoke free magnets make beam injection/extraction possible even in arc section, but they make leakage field larger.

Beam intensity can be improved by cure of beam loss. \rightarrow but at most a few nA \rightarrow change the injection scheme

H- injection



Beam injection to the main ring

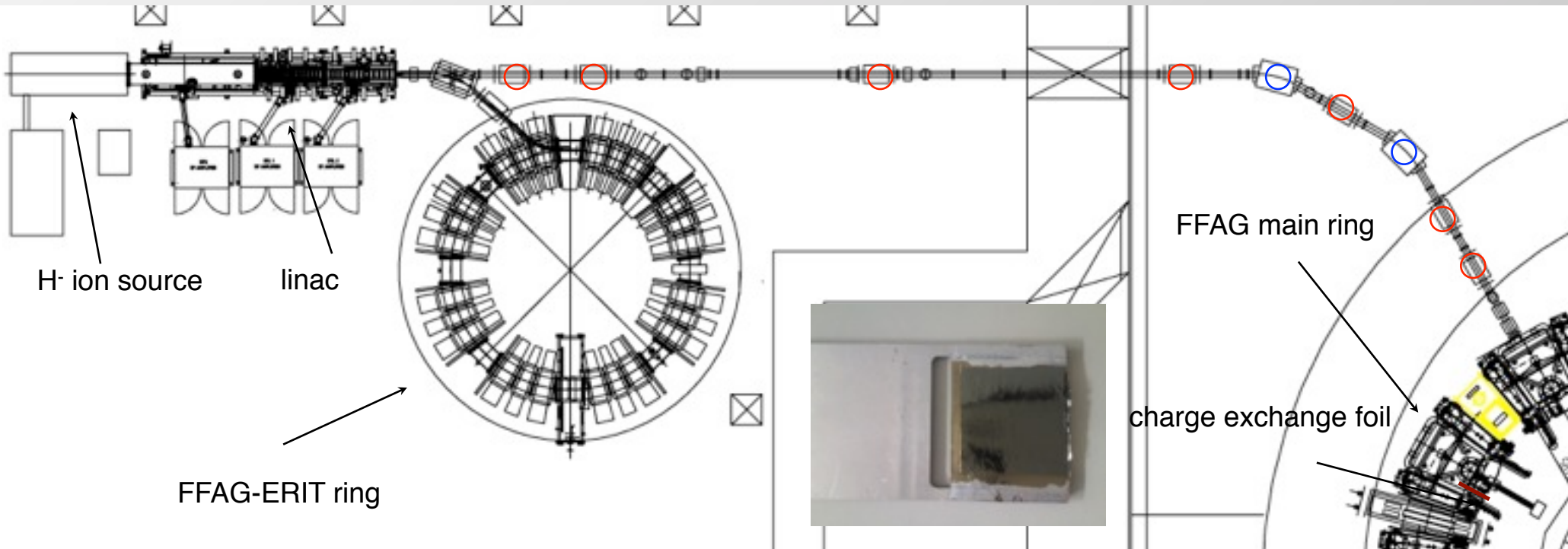
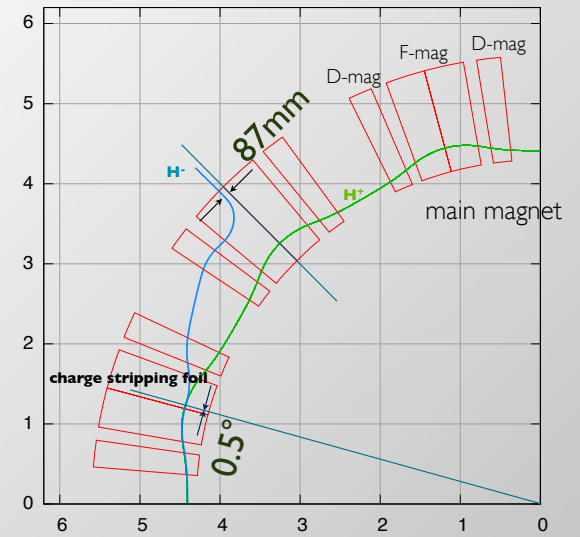

What we did since the last workshop

FFAG I I

- Remove the injection septum magnet →
correction/reduction of COD
- Move the rf cavity outward by 5 cm →
energy up from 100 to 150 MeV
- Kicker system upgrade →
extraction efficiency has been improved
- Add two quads in the transport line →
transport efficiency has been improved

BMBT



injection septum
magnet

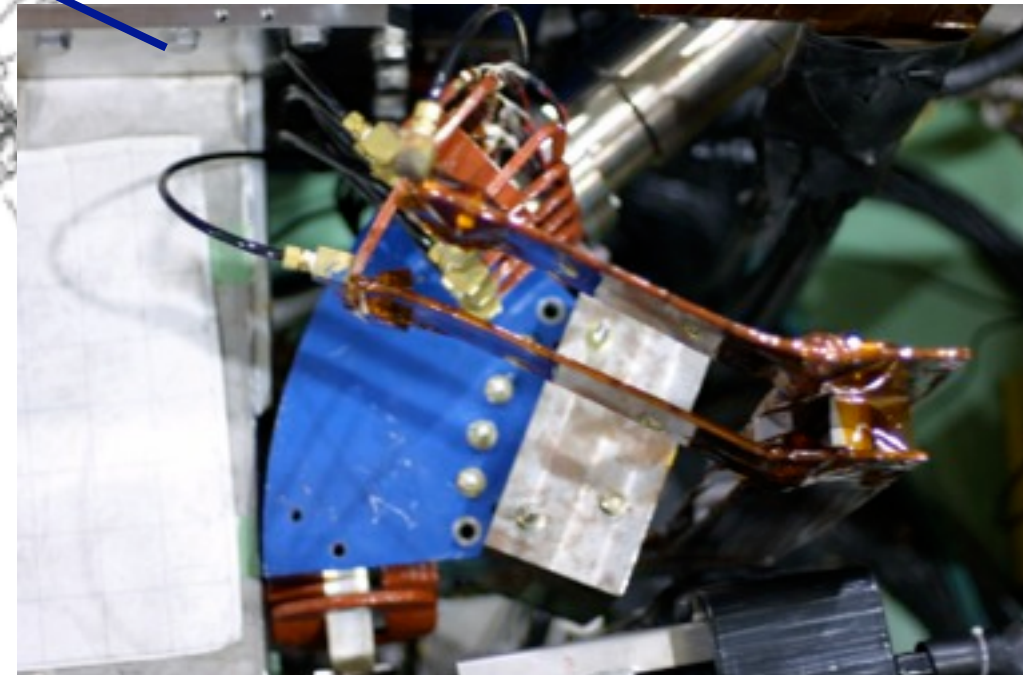

Do not use magnetic stuff even for a base

Test_07-12-18

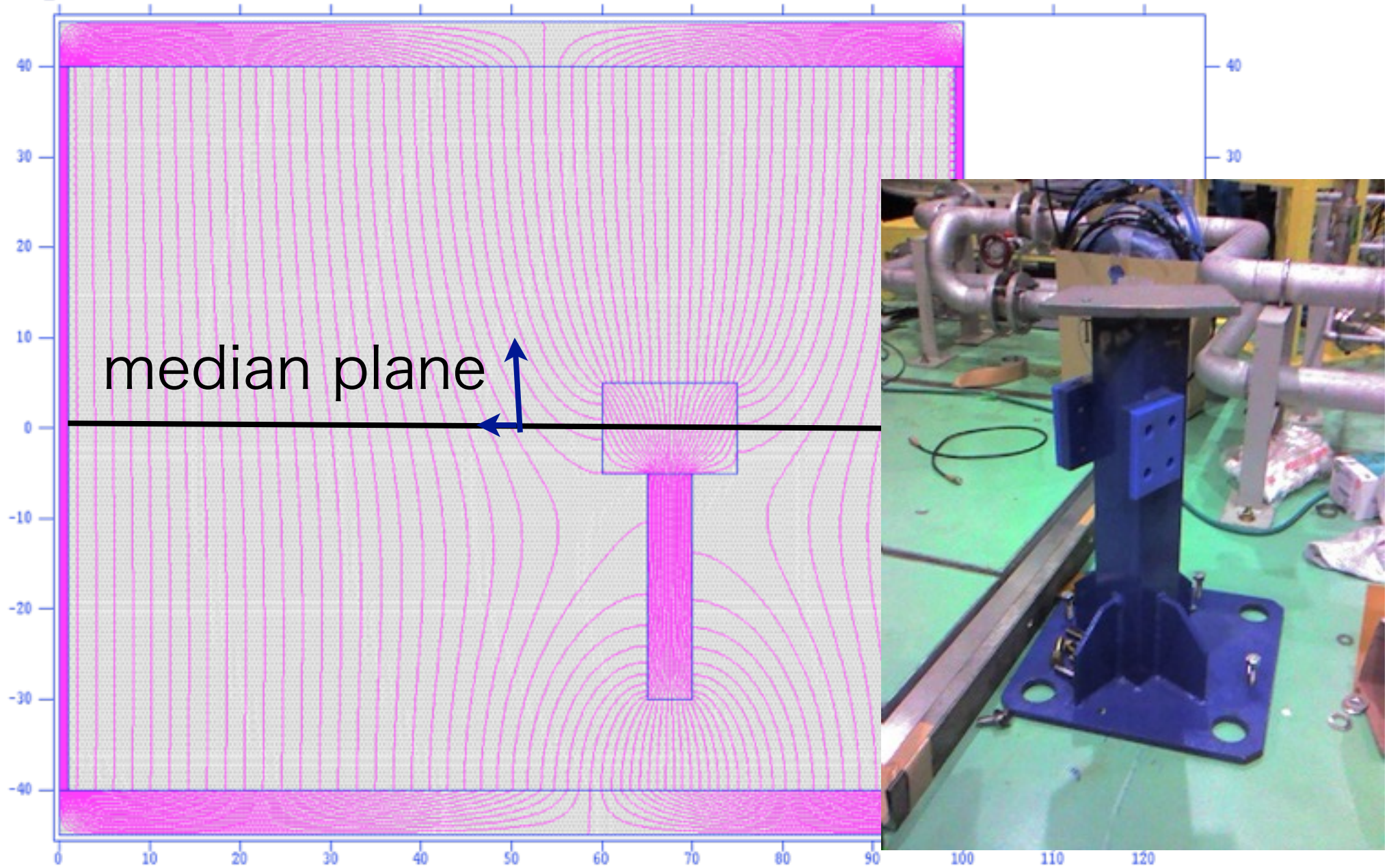

Remove SMI

It is not used for injection for H- beam, but has to be excited to circulate the injected beam.

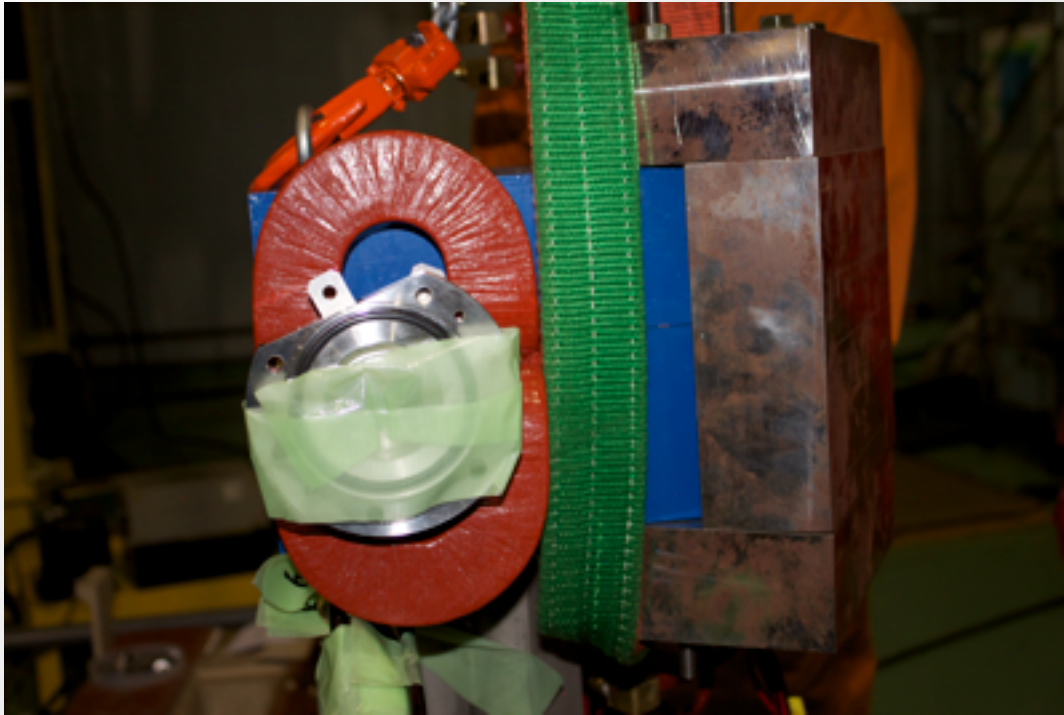

Field absorption by SMI causes a quadrupole error as well as a dipole error.

After removing SMI, the strongest COD source must be the cavity.

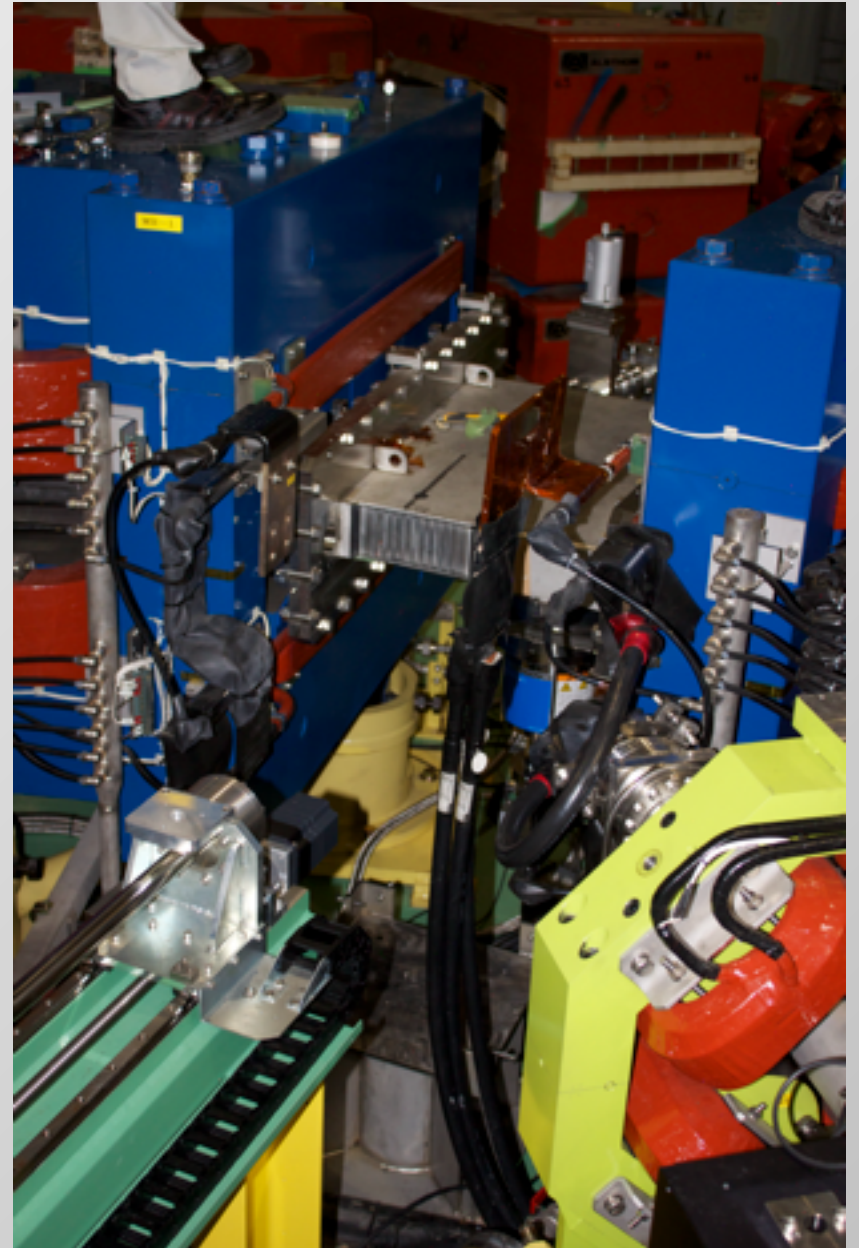

COD correction by the correction dipoles

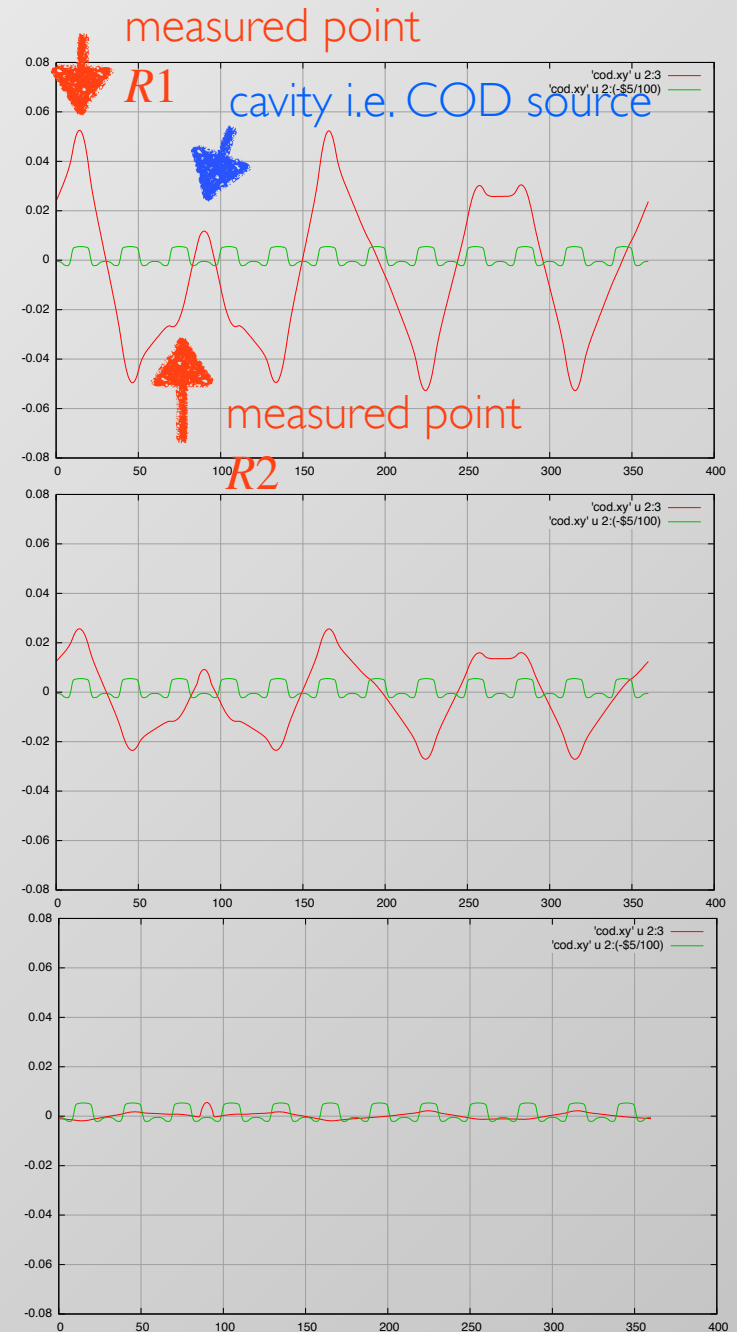
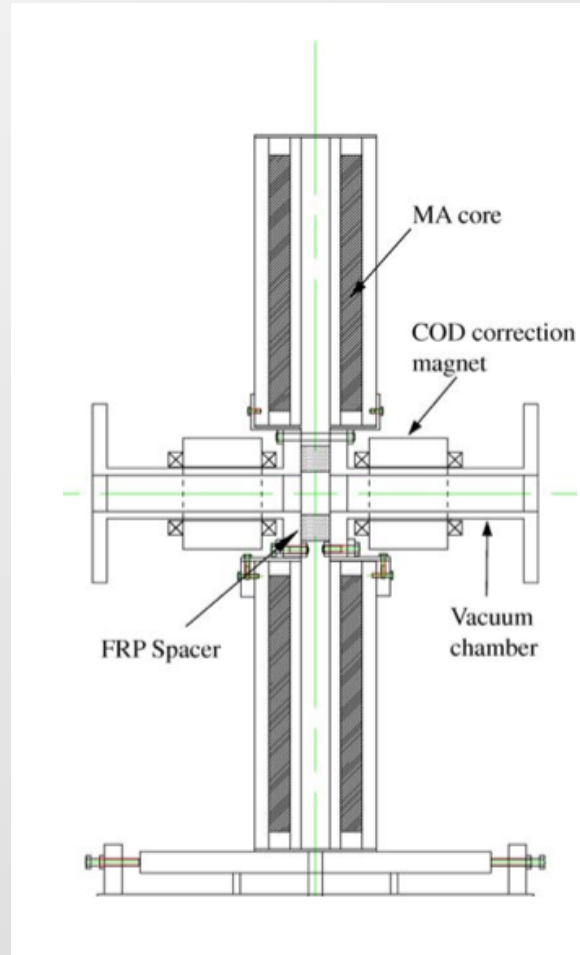

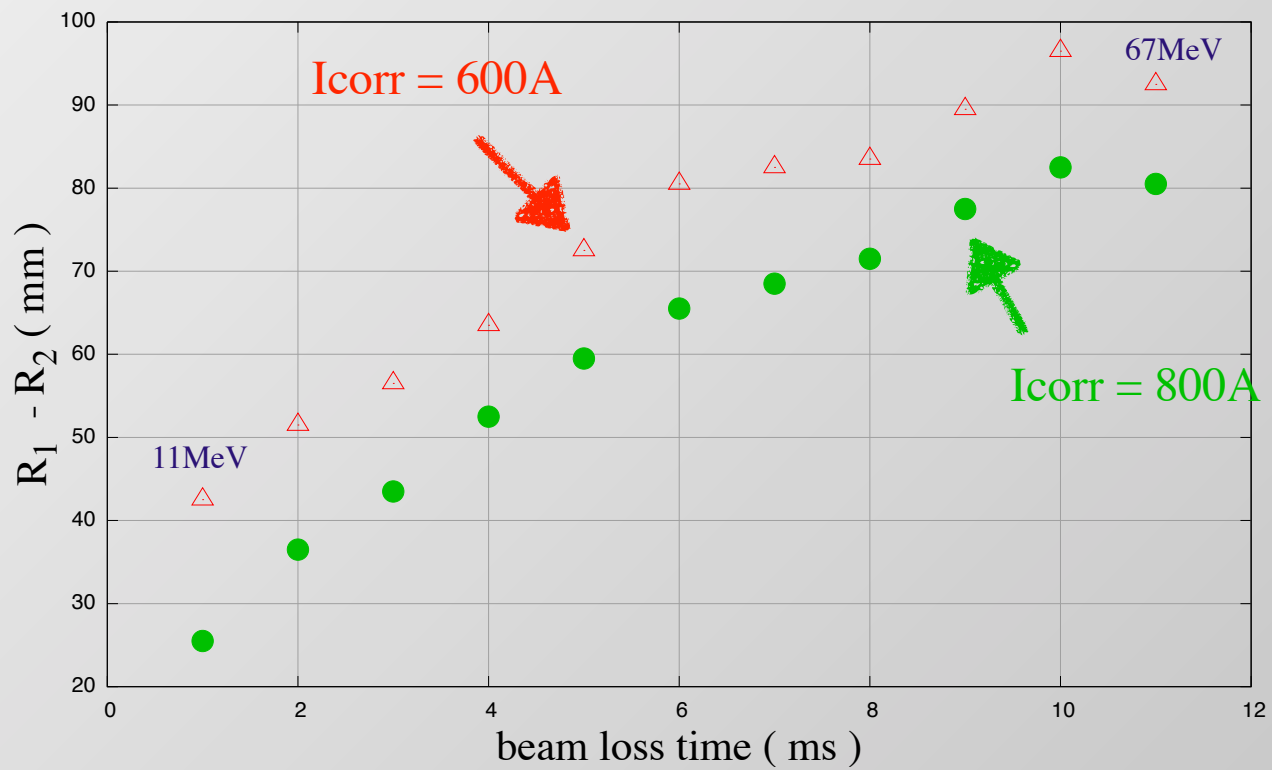
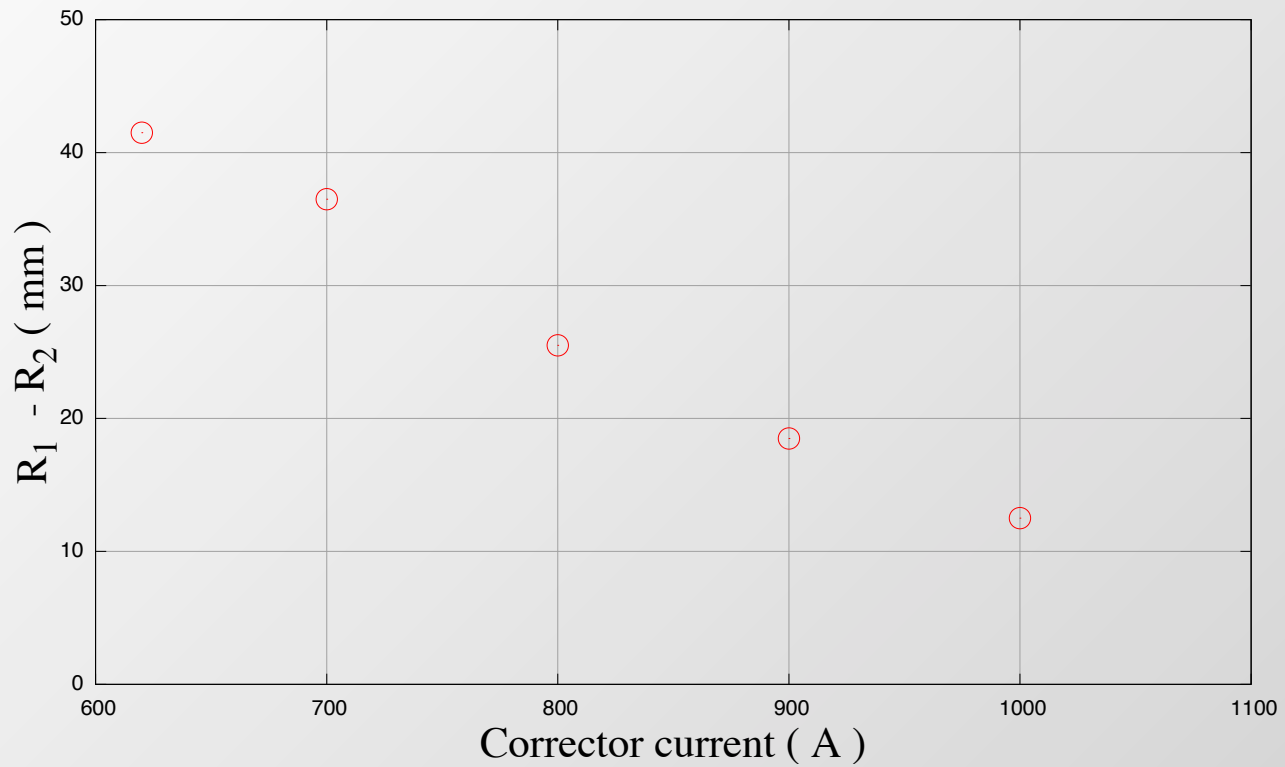

Shift rf cavity outward by 5cm

R at the center of the
straight section (m)

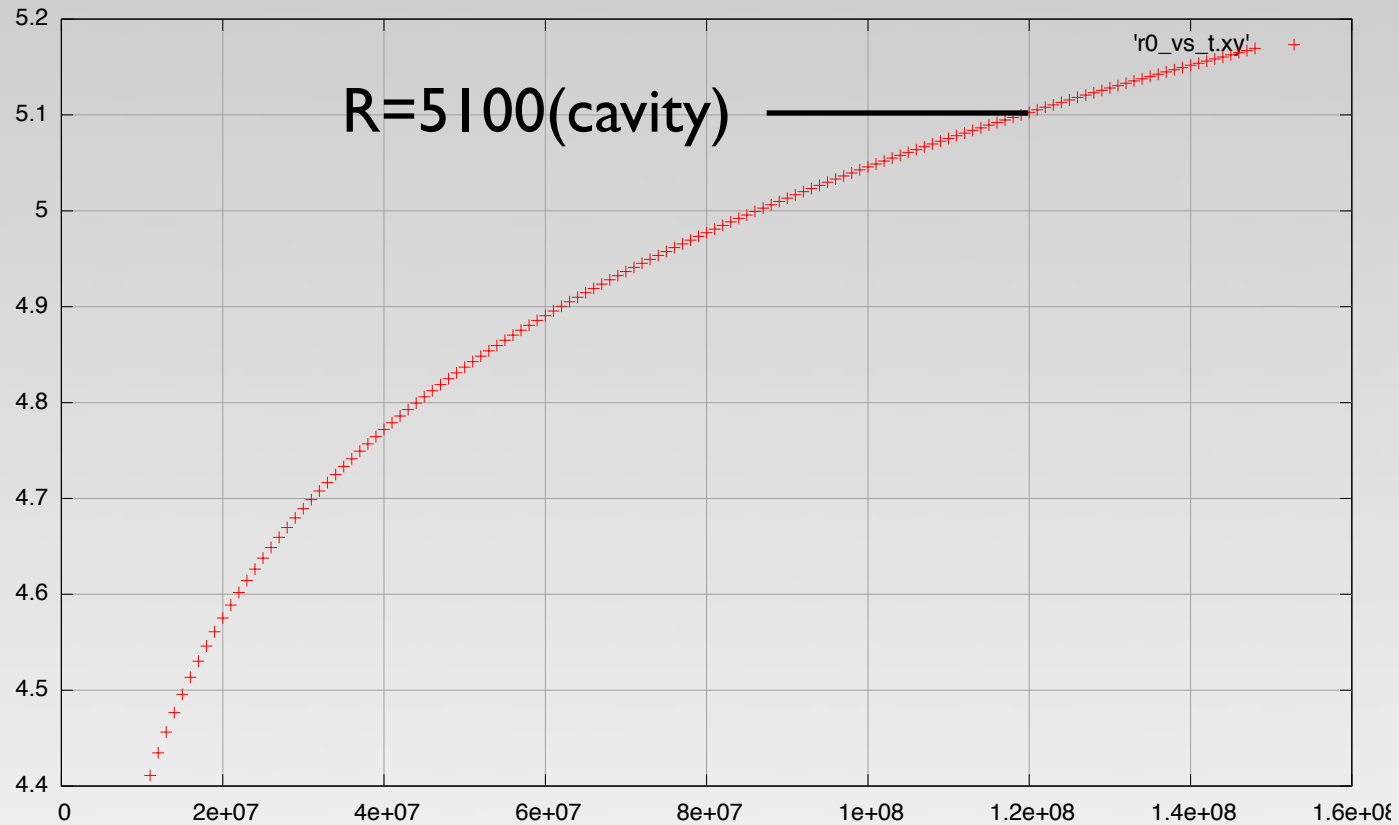

Kinetic energy (eV)

Problems of new configuration of the cavity

- COD correction magnets have been also moved outward by 5cm with the cavity
- Vertical tune has been shifted close to $\nu_y = 1.5$ by Q fields from the inner edge of the poles of the correction magnets.
- Correction field should be reduced to avoid the resonance

$$2\nu_y = 3$$

Main ring operating point

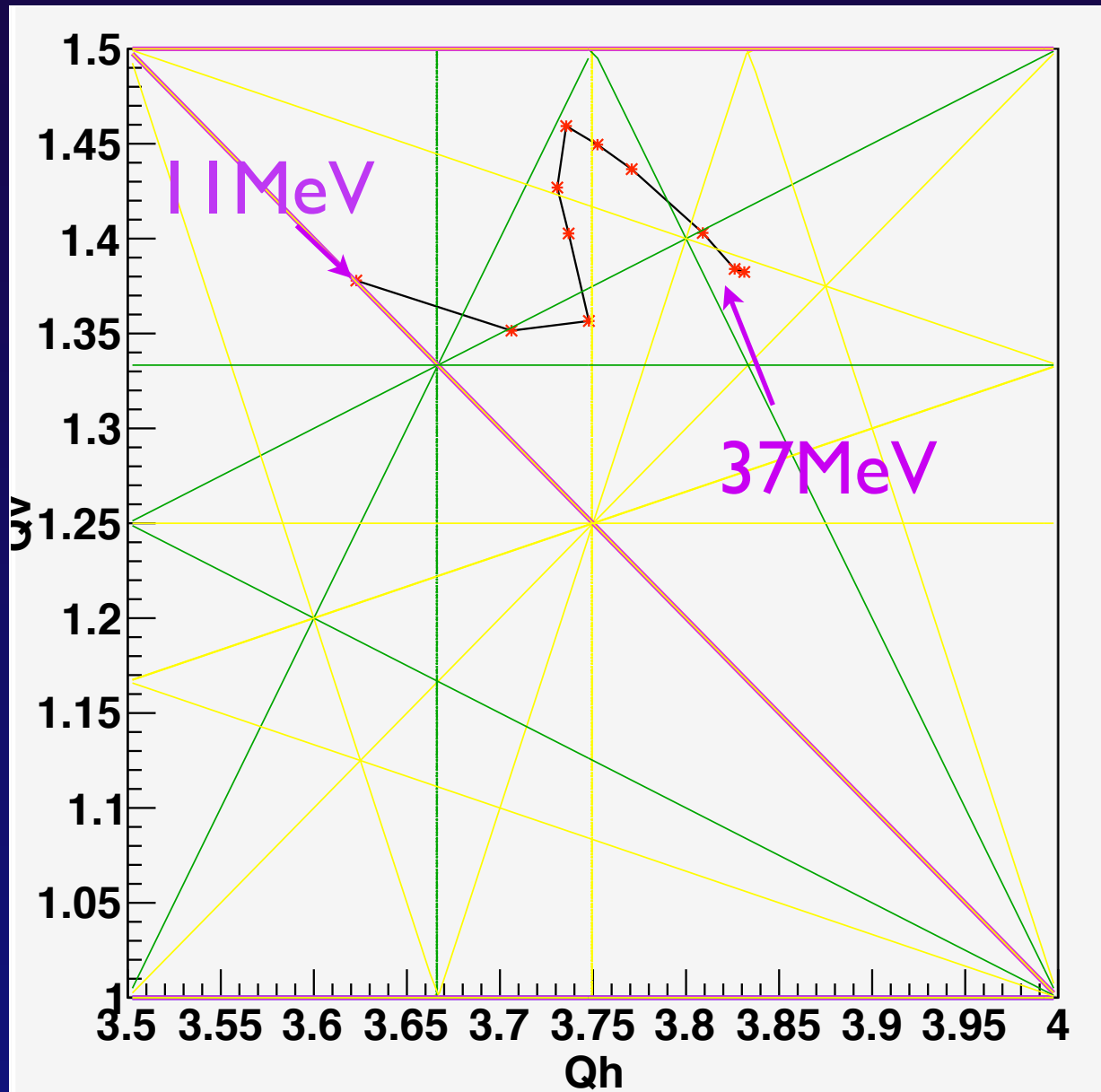

Original System

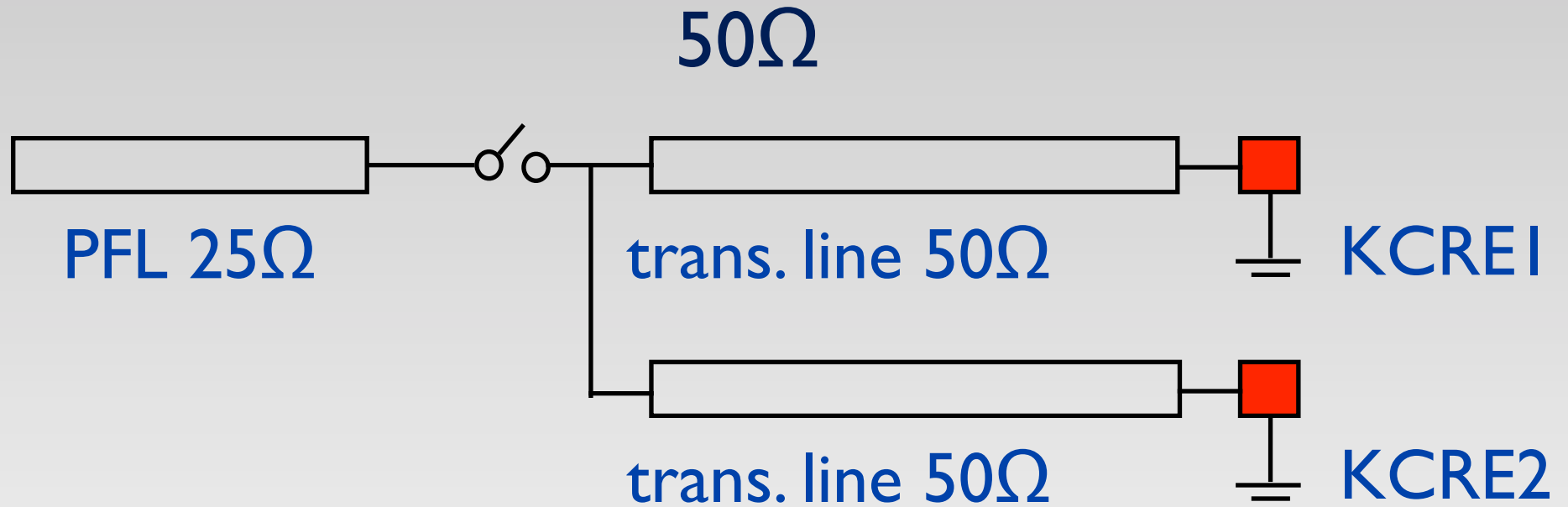

In this system, we can not adjust trigger timing or current of each kicker independently.

Upgraded System

MR KCRE PS

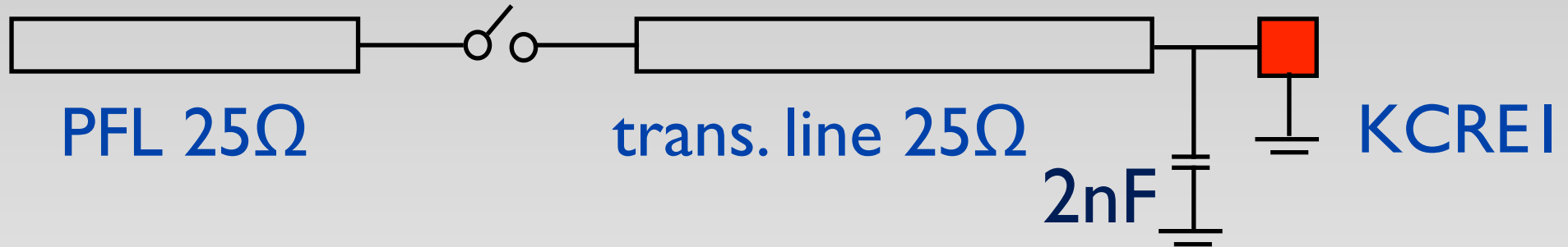

MR KCRI PS

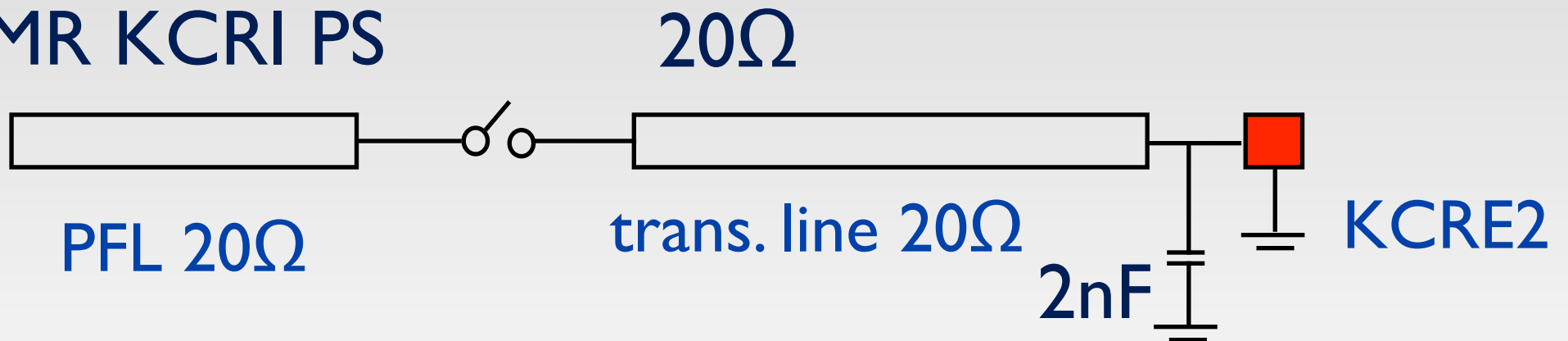

- Reuse the injection kicker power supply
- Reduce impedance from 50Ω to 25(20)Ω
- Add speed-up capacitor

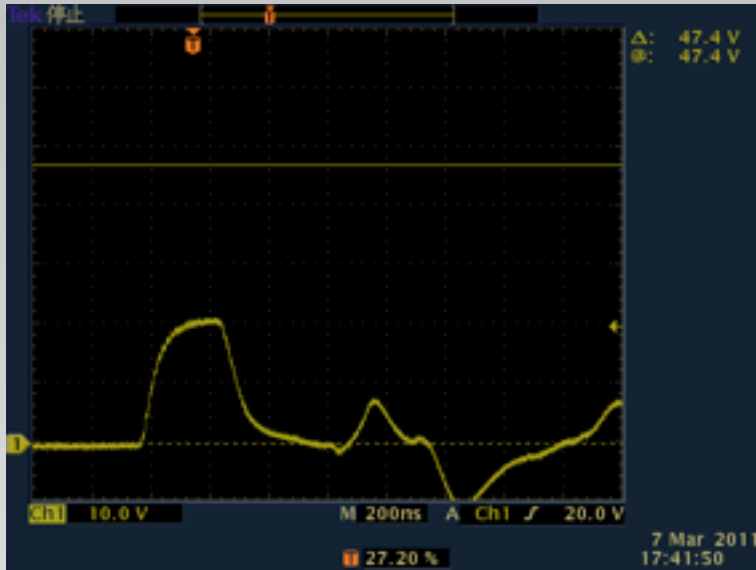

50Ω 2-turn(2.4uH)

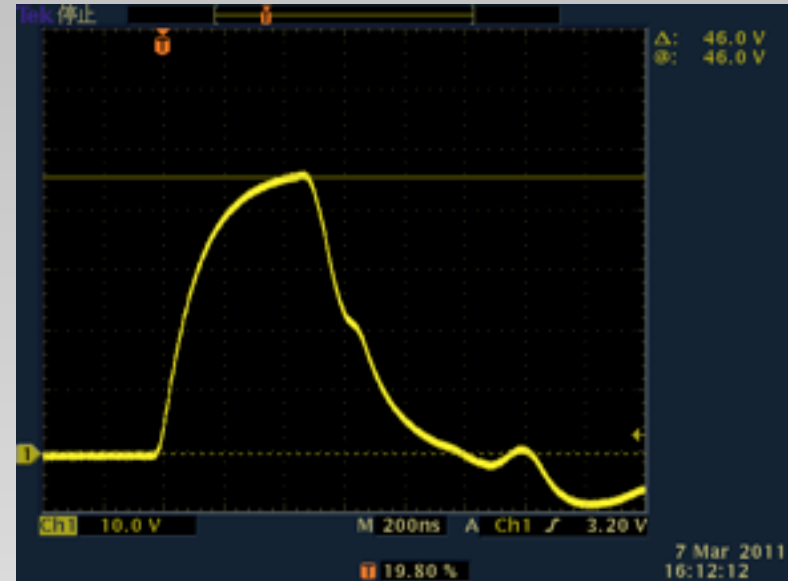

20Ω 2-turn(2.4uH)

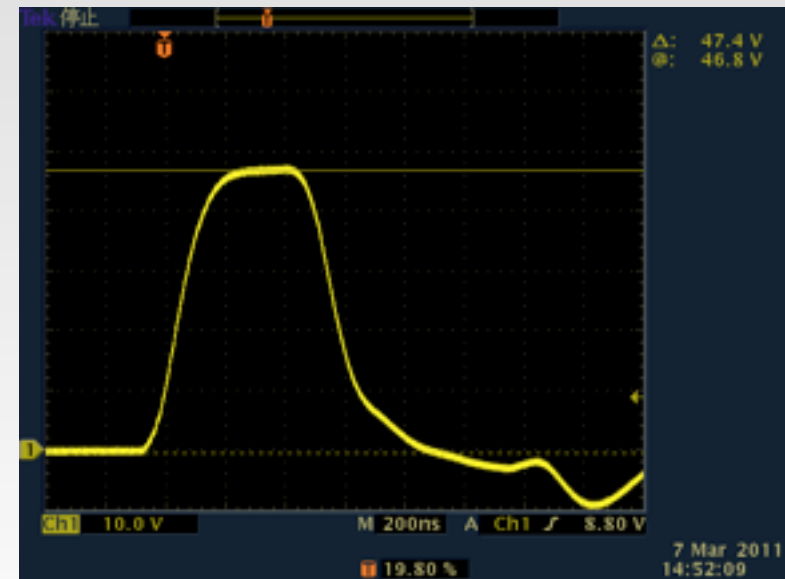

20Ω 2-turn(2.4uH,2nF)

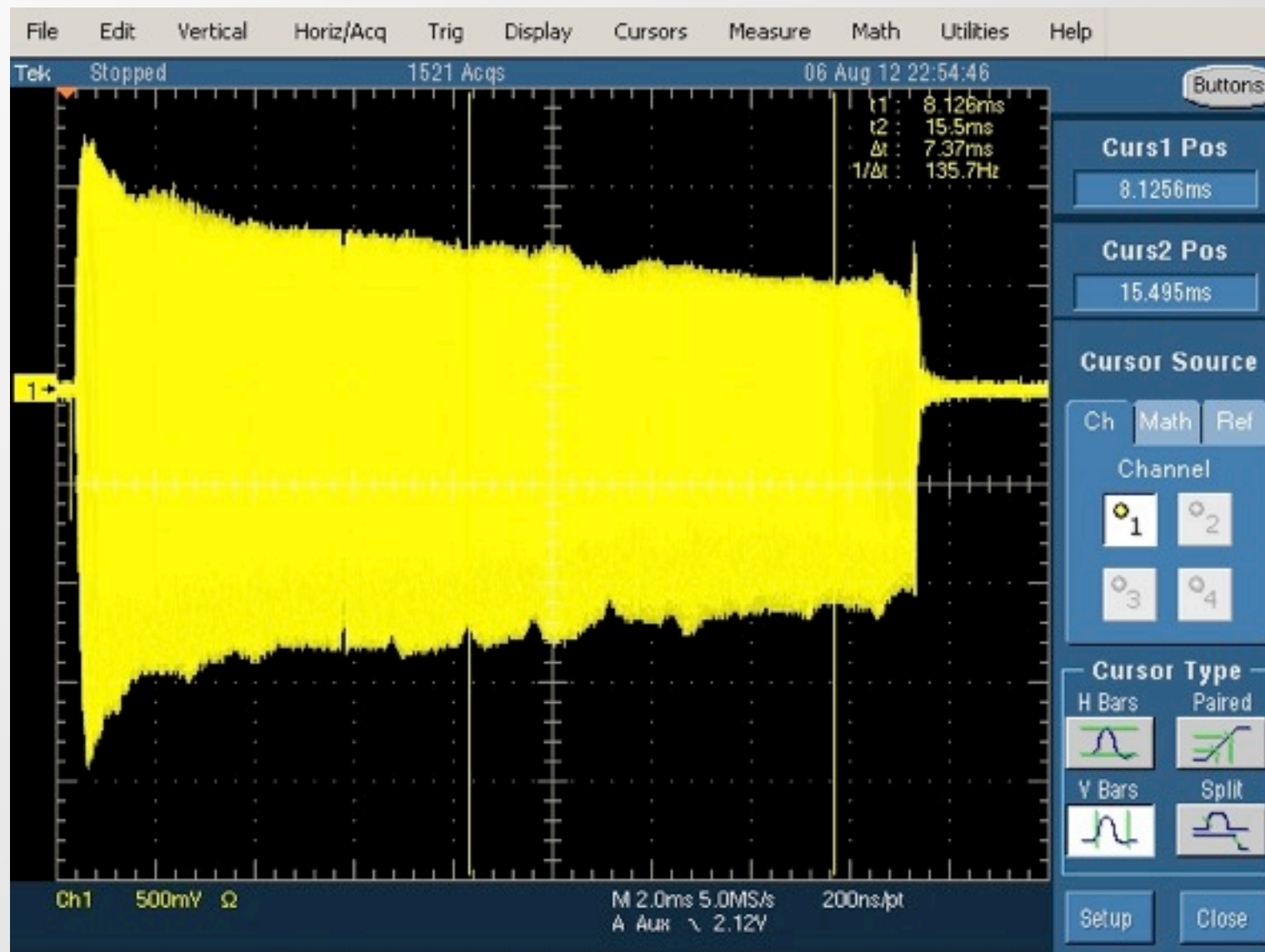

Intensity has been increased by 200 times from the beginning of the ADNR experiment

At the
irradiation
experiment

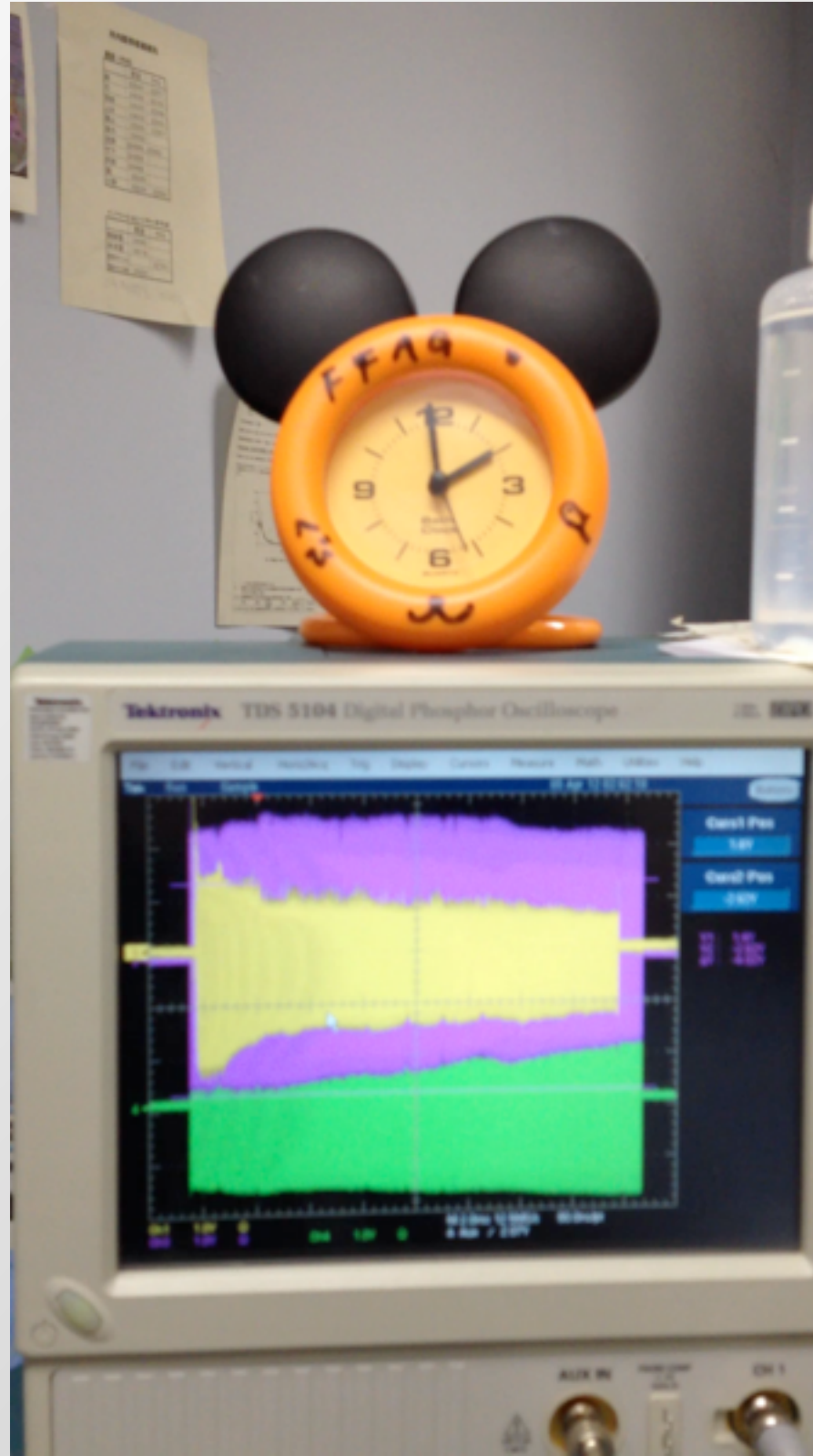

Good rf,
stable
beam!

History of beam intensity and energy upgrade in recent 4 years

March 2009 (starting ADSR exp.)

100MeV 50pA

improve transport efficiency
(cavity voltage up 2.5kV → 4kV)

March 2010

100MeV 100pA

H- injection

March 2011

100MeV 1nA

improve extraction efficiency

March 2012

100MeV 10nA equivalence *

energy up (shift the cavity outward)

November 2012

150MeV 10nA equivalence *

* radiation safety limit is 1nA (run at low rep. rate)

FFAG BEAM INTENSITY UPGRADE ROAD MAP

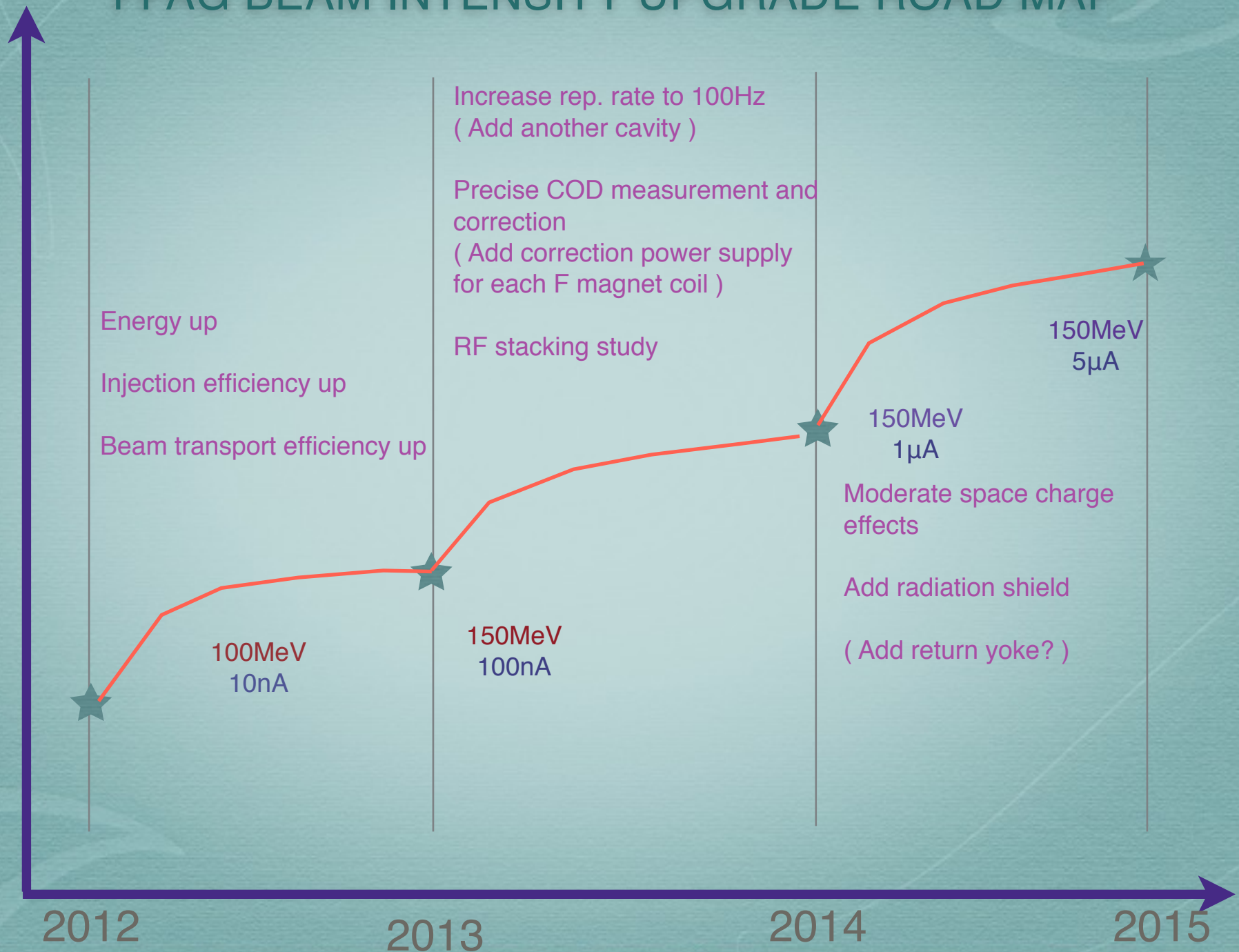

FFAG users in KURRI

- Now
 - ADSR experiment (100MeV / 1nA)
 - Irradiation experiment for material engineering (higher the better : 150MeV / 10nA)
- Future
 - proton users (irradiation, cancer therapy : BNCT complementary)
 - neutron users
 - pulsed neutron : essential for TOF measurement
 - ADSR : MW beam power -> 700MeV FFAG

A plan of pulsed neutron source based on linacs and FFAG in KURRI

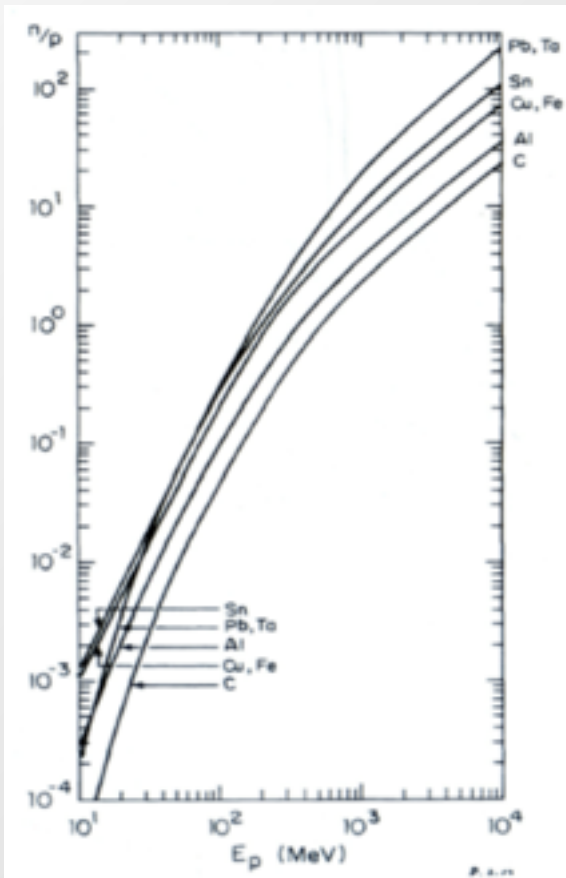
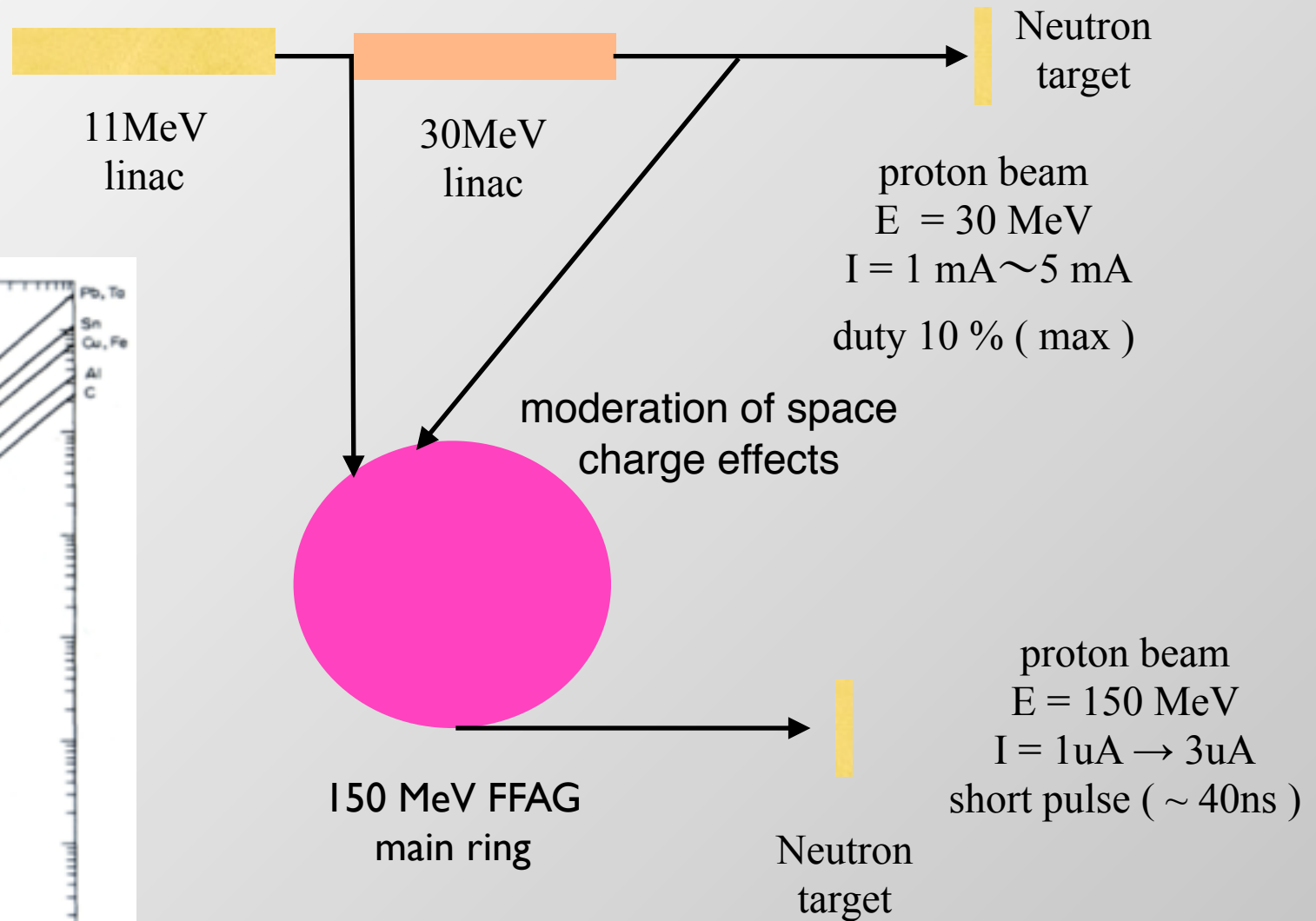

RF stacking at the extraction energy

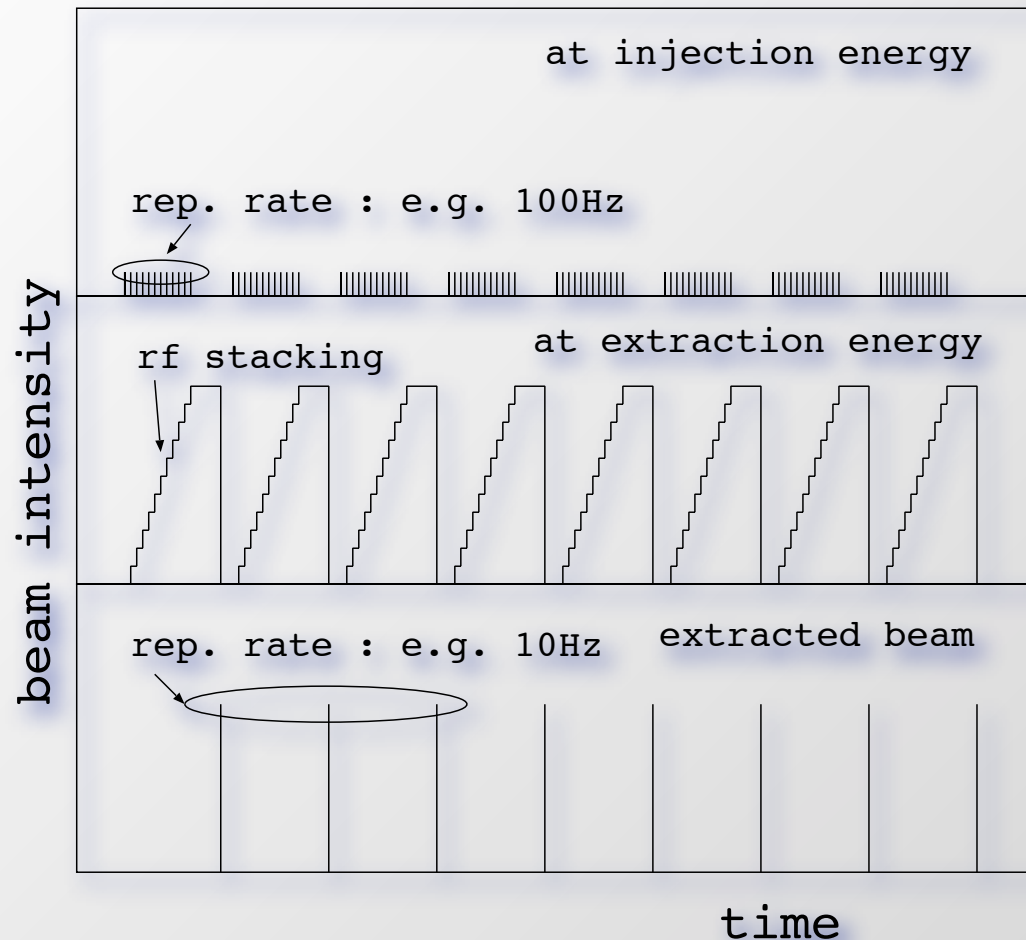

Some users desire low spill rate (~ 10 Hz) for the experiments e.g. neutron radiography using TOF which needs to get rid of contamination from the pulse of different timing.

FFAG rings can provide long interval pulse for users, while the machine operation itself is kept at high repetition rate by using rf stacking after acceleration [1].

This scheme reduces space charge effects at injection energy.

[1] S.Machida, "RF Stacking at Extraction Momentum", FFAG Workshop 2003, October 13-17, 2003 at BNL, <http://www.cap.bnl.gov/mumu/conf/ffag-031013/Machida2.pdf>.

Machine parameters used in the simulation

field index k	7.7
kinetic energy T	11 - 150 [MeV]
momentum p	144 - 551 [MeV/c]
circumference C	28.8 - 33.6 [m]
momentum compaction factor α	0.115
rf voltage V_{rf}	8 [MV]
rf frequency f_{rf}	1.6 - 4.4 [MHz]
harmonic number h	1

RF Scenario

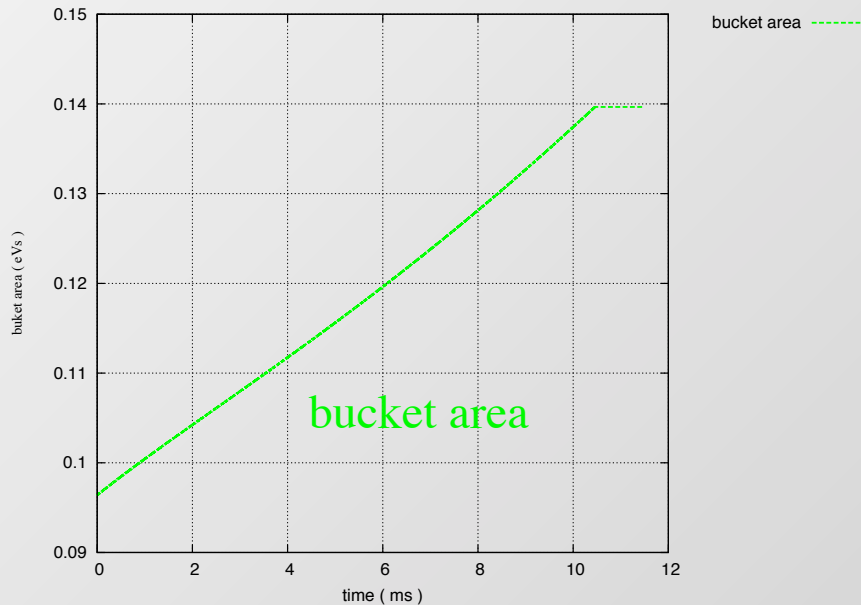
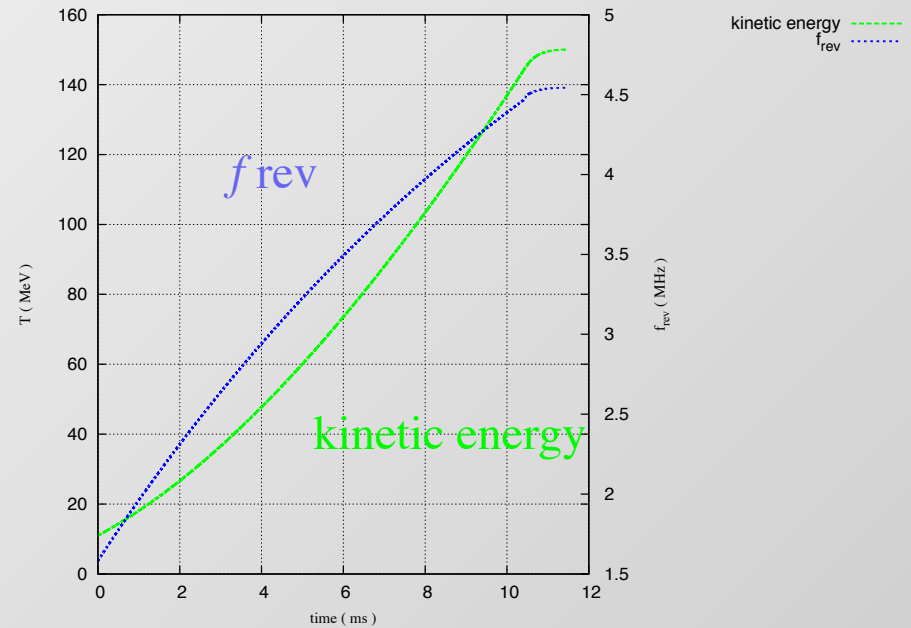
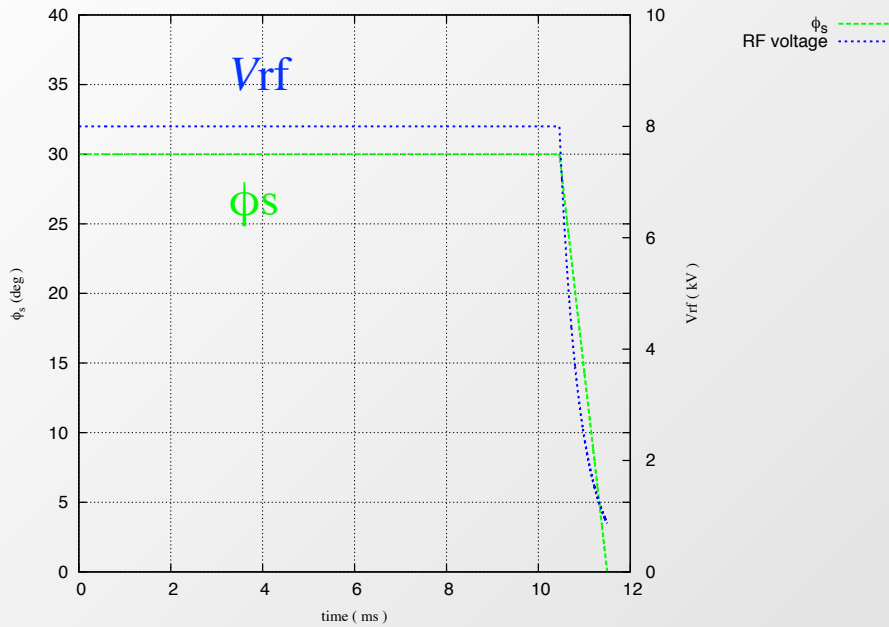

In the real machine operation, we use similar scenarios in which synchronous phase ϕ_s and rf voltage are fixed at 30 degree and 4 kV respectively during all the acceleration period. On the other hand, in the scenario used in this simulation study, ϕ_s is dropped off linearly from 30 to zero degree when the energy of the beam is between 145 and 150 MeV for soft-landing. The rf voltage is also reduced in this region so that the bucket area is constant in order to make momentum spread small at the end of acceleration.

1st batch

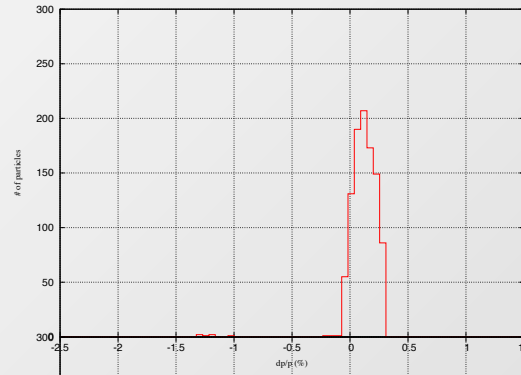
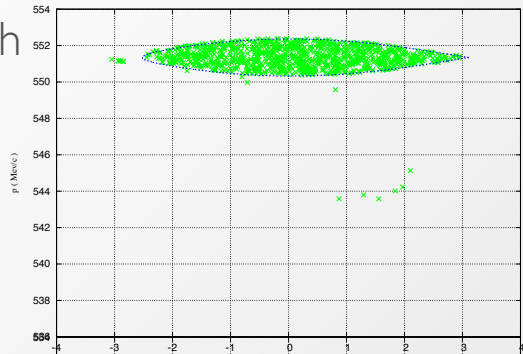

2nd batch

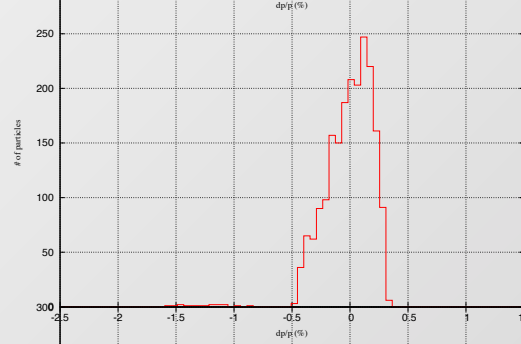
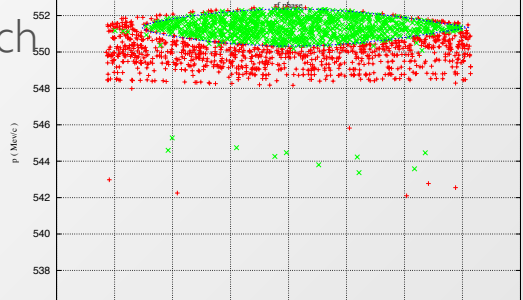

5th batch

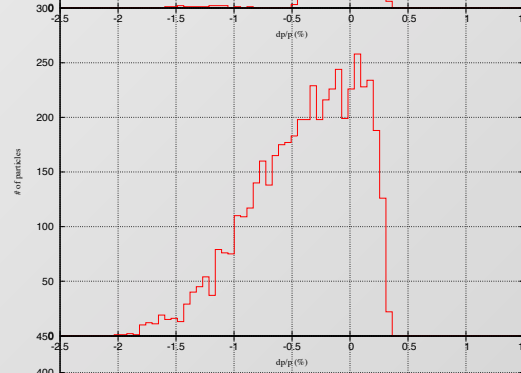
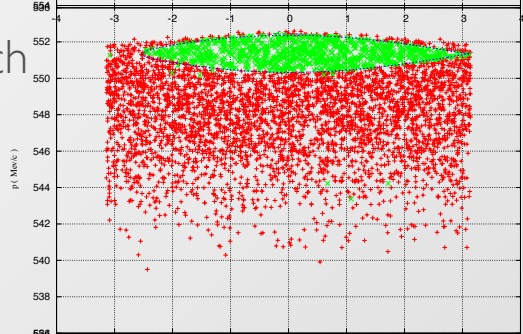

10th batch

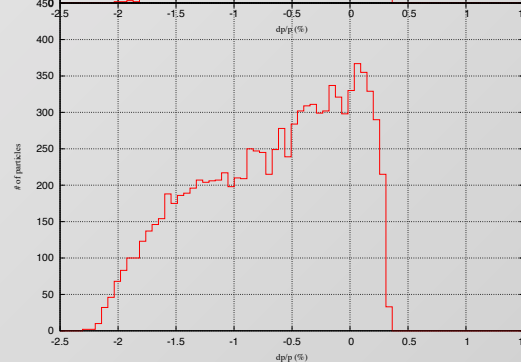
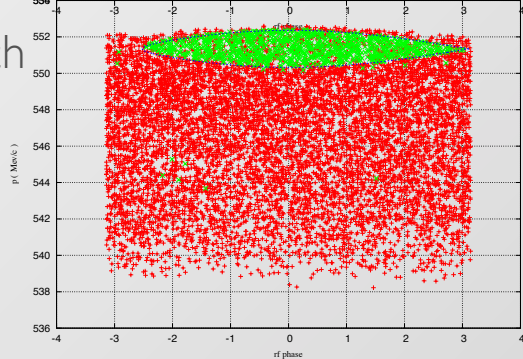

Stacking processes are simulated using 1 000 test particles for each acceleration batch. After first acceleration, full width of momentum spread is about 0.5%, the final momentum spread after 10 stacks is 2.5% of full width.

w/ soft-landing

1st batch

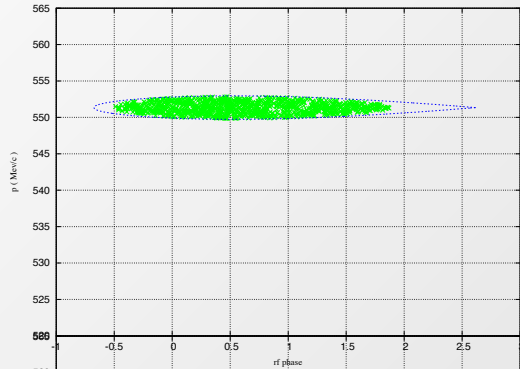

5th batch

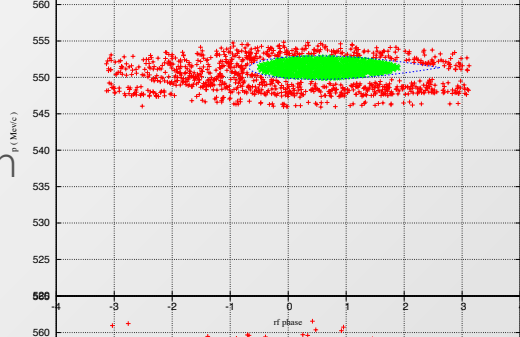

10th batch

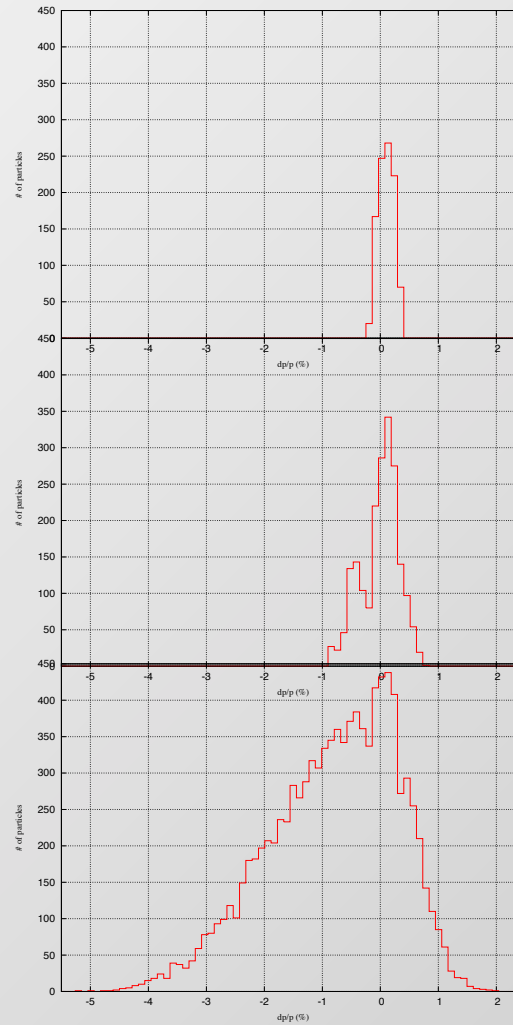
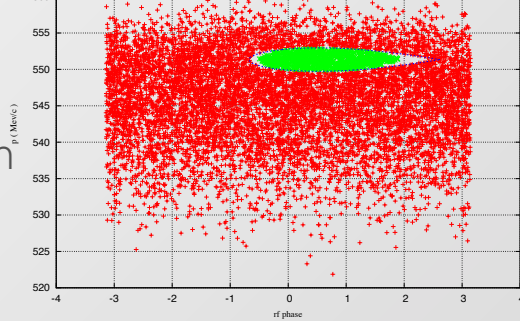

Without soft-landing the final momentum spread after 10 stacks is 5% of full width i.e. twice as large as with soft-landing.

w/ soft-landing

Perturbation from the rf bucket to the coasting beam

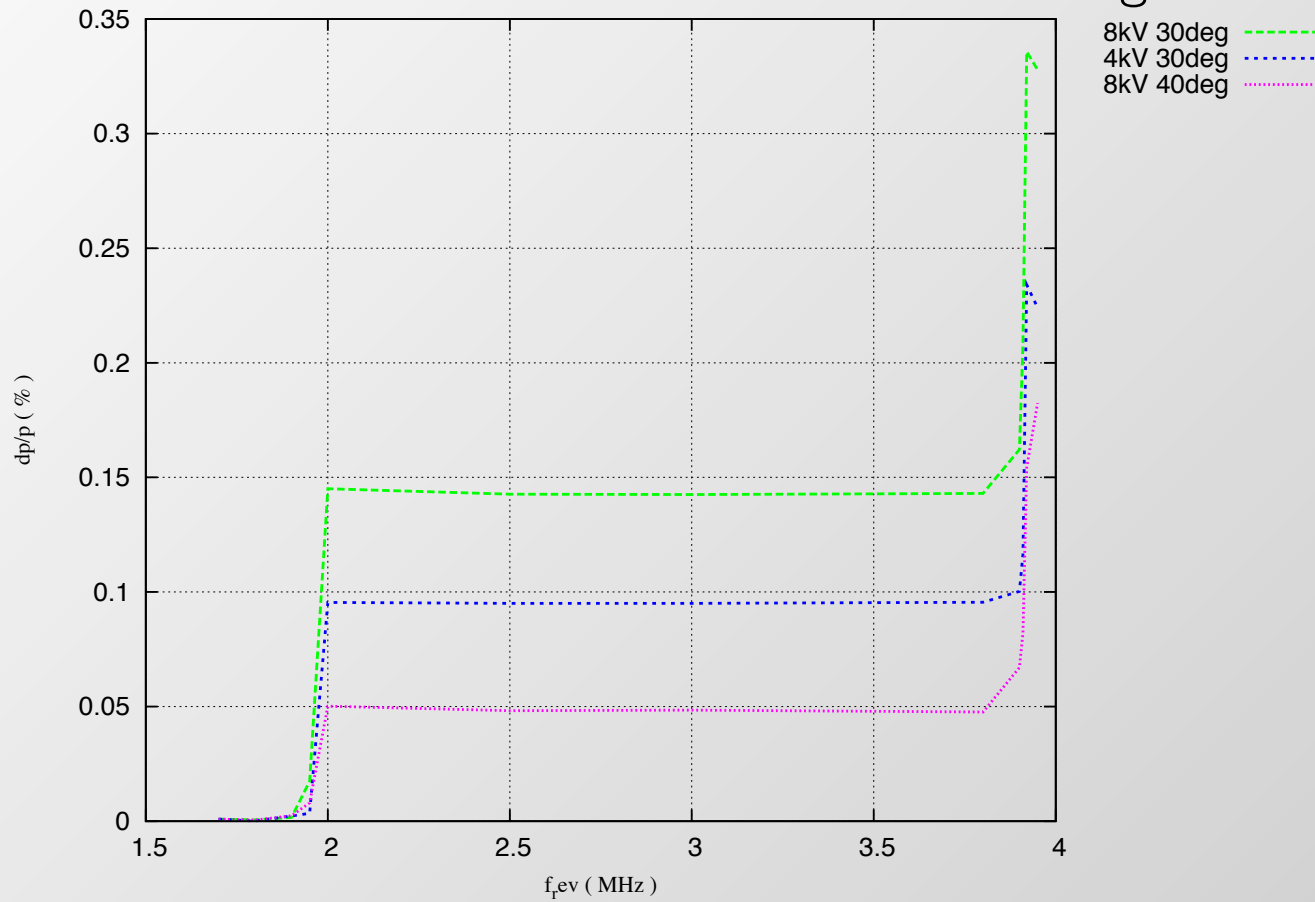

Check if the acceleration bucket affects the stacked beams coasting around the extraction orbit. Generate zero emittance test beam (100 MeV) with $\Delta p/p = 0$ and uniformly distributed in the rf phase.

Check if momentum spread is blowing up, while the accelerating bucket is coming up.

There are two steps around 2 MHz and 4 MHz in each case.

Step around 4 MHz : direct disturbance of the bucket.

Step around 2 MHz : $f_{\text{drive}} = 1/2 f_{\text{rev}}(\text{stack})$

It seems that coasting beam can be affected when the accelerating bucket is passing through the frequency which is half of revolution frequency of the coasting beam.

Summary

- The beam intensity has been increased from 1 nA to 10 nA because of following upgrades:
 - improvement of ring symmetry by removal of SMI and increasing correction magnet field.
 - improvement of extraction efficiency by the kicker system upgrade
- Energy upgrade has been done, 100 MeV → 150 MeV
- For the pulsed neutron source, beam stacking at the extraction energy is essential.
- Simulation studies of the stacking has been done.
- Stacking experiments are planned to be done in next year.